

Pos. Nr. Pos. no. Position	Art.-Nr. Art.no. Réf.	Beschreibung Description Désignation	Preisgruppe Price bracket Catégorie de prix
1	85111	Motor	57
2	85622	Haftringesatz	19
3	85808	Schraube	2
4	86102	Beilagscheiben	2
5	86208	Zugfeder	2
6	86413	Schneckenzahnrad	4
7	86520	Zahnrad	2
8	87838	Motorplatine kpl.	38
9	89282	Universal. Kupplung	5
10	89749	Schneckenachslager	6
11	100075	Kardansatz	11
12	100644	Brückenstecker	7
13	105764	Distanzplättchen	2
14	108616	Drahtlampe 16 V	10
15	109879	Lampenhalter mit Zapfen	2
16	112501	Grundrahmen	35
17	112502	Schneckendeckel m.Stab.Feder	8
18	112558	Teilesatz	8
19	112553	Getriebeboden-Kinematiks.	7
20	112557	Deichsel-Puffersatz	7
21	112506	Lampen-Flexplatine	15
22	112507	Schneckensatz kpl.	24
23	112546	Gehäuse kpl. 63465	58
24	112547	Zurüstbeutel	24
25	112550	Radsatz m. 1 Haftring	20
26	112549	Radsatz m. 2 Haftringen	20
27	112548	Radsatz o. Haftring D=10,8	18
28	112551	Blende 1 kpl.	12
29	112554	Getriebebesatz	18
30	112555	Blende 2 kpl.	12
31	112516	Fenster-Lichtleitersatz	18
32	112556	Teilesatz	7
33	112560	Frontgriff-Auftrittsatz	8
34	112561	Lichtblende	2
35	112520	Gehäuse kpl. 63469	2
36	112559	Attrappenrahmen klein	3
37	112563	Türgriffsatz	14
38	112552	Teilesatz	17
39	112524	Radkontaktsatz	7
40	112562	Teilesatz	7
1	85111	Motor	57
2	85622	Traction tires set	19
3	85808	Screw	2
4	86102	Spacer	2
5	86208	Spring	2
6	86413	Worm gear	4
7	86520	Gear	2
8	87838	Printed circuit assembly	38
9	89282	Universal coupling	5
10	89749	Worm axle bearing	6
11	100075	Cardan set	11
12	100644	Connector	7
13	105764	Spacer	2
14	108616	Light bulb	10
15	109879	Lamp holder	2
16	112501	Main frame	35
17	112502	Worm cover w. vibration damper	8
18	112558	Parts set	8
19	112553	Gearbottom and kinematics	7
20	112557	Drawbar and Buffer-set	7
21	112506	Bulb printed	15
22	112507	Worm set cpl.	24
23	112546	Body assembly 63465	58
24	112547	Bag with accessoires	24

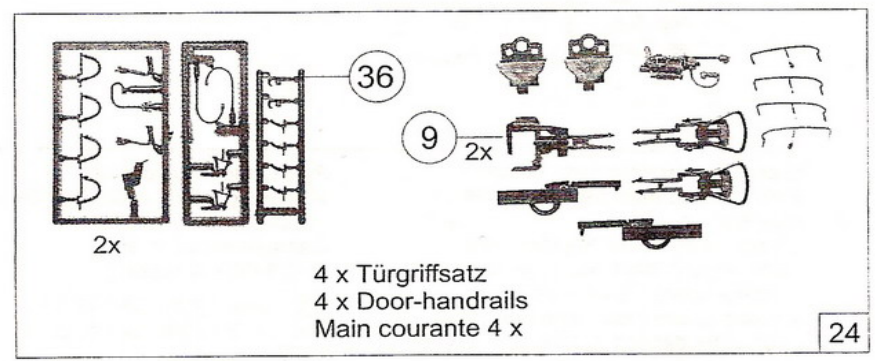

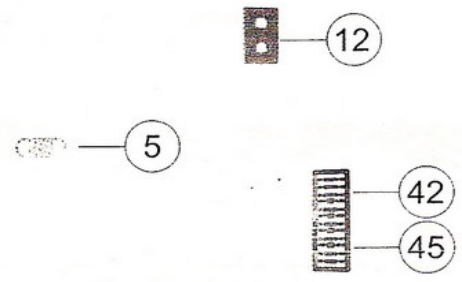
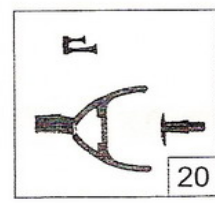
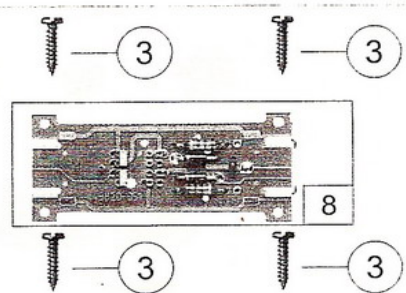
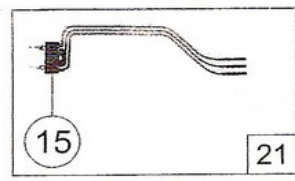
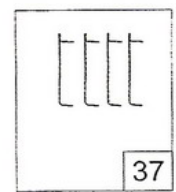
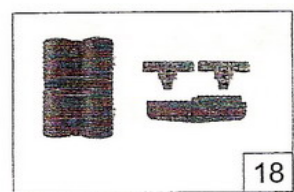
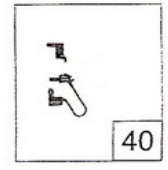
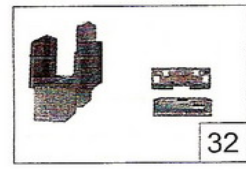
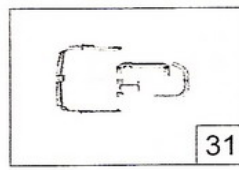
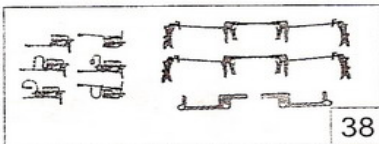
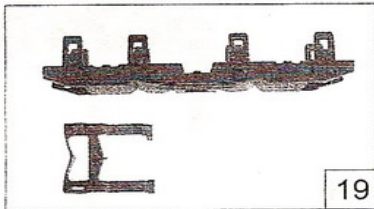
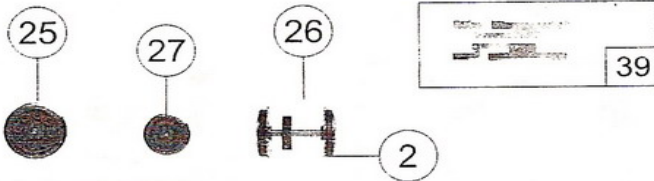
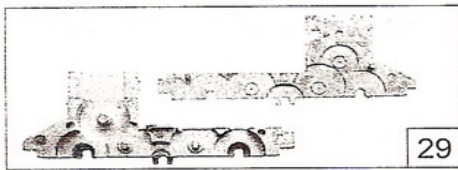
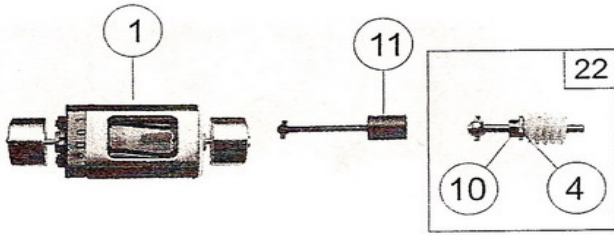
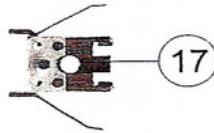

Pos.Nr. Pos.no. Position	Art.-Nr. Art.no. Réf.	Beschreibung Description Désignation	Preisgruppe Price bracket Catégorie de prix
25	112550	Wheelset with 1 traction tyre	20
26	112549	Wheelset with 2 traction tires	20
27	112548	Wheelset without traction tyre	18
28	112551	Bogie cover 1 cpl.	12
29	112554	Gear part set	18
30	112555	Bogie cover 2 cpl.	12
31	112516	Window- and light transmission set	18
32	112556	Parts set	7
33	112560	Handle set	8
34	112561	Light cover	2
35	112520	Body assembly 63469	2
36	112559	Push in part set, small	3
37	112563	Door handle set	14
38	112552	Parts set	17
39	112524	Wheel contact set	7
40	112562	Parts set	7
1	85111	Moteur	57
2	85622	Bandagee d' adhérence	19
3	85808	Vis	2
4	86102	Rondelle	2
5	86208	Ressort	2
6	86413	Pignon de la vis sans fin	4
7	86520	Pignon	2
8	87838	Circuit imprimé	38
9	89282	Attelage universel	5
10	89749	Palier de l'axe de la vis sans fin	6
11	100075	Jeu de transmission à cardan	11
12	100644	Fiche de shuntage	7
13	105764	Entretoise	2
14	108616	Ampoule à électrodes 16 V	10
15	109879	Support d'ampoule	2
16	112501	Chassis principal	35
17	112502	Couvercle »vis sans fin« complet	8
18	112558	Jeu de pièces	8
19	112553	Couvercle du carter d'engrenage	7
20	112557	Timon/jeu de tampons	7
21	112506	Circuit imprimé flexible à ampoules	15
22	112507	Jeu de vis sans fin, complet	24
23	112546	Caisse complet réf. 63465	58
24	112547	Sachet des pièces de finition	24
25	112550	Essieu à roue bandagées	20
26	112549	Essieu à roue bandagées	20
27	112548	Essieu à roues non bandages	18
28	112551	Flancs de bogie 1, complet	12
29	112554	Jeu d'engrenages	18
30	112555	Flancs de bogie 2, complet	12
31	112516	Jeu de fenêtres	18
32	112556	Jeu de pièces	7
33	112560	Jeu de mains courantes	8
34	112561	Cache-lumière	2
35	112520	Caisse complet réf. 63469	2
36	112559	Grappe de pièces rapportées	3
37	112563	Jeu de poignées	14
38	112552	Jeu de pièces	17
39	112524	Lame de contact	7
40	112562	Jeu de pièces	7

Ersatzteile erhalten Sie bei Ihrem Fachhändler, Ihrer Landesvertretung, oder bei:

You can order your Replacement Parts at your local dealer, your country representative, or:

Passez commande des pièces détachées chez votre détaillant, chez le S.A.V. de votre importateur national ou en direct au S.A.V. Roco

ROCO Modellspielwaren Vertriebsg.m.b.H & Co. Handels KG - Service - Georg-Wrede-Str. 49 D - 83395 Freilassing

☎ +49 / (0)86 54 / 47 63 0
Fax: +49 / (0)86 54 / 47 63 50

eMail: service@roco-online.de